

# LCD Digital Counters (Indicator)



## LA8N Series PRODUCT MANUAL

**For your safety, read and follow the considerations written in the instruction manual, other manuals and Autonics website.**

The specifications, dimensions, etc. are subject to change without notice for product improvement. Some models may be discontinued without notice.

### Features

- No additional power due to internal battery
- Signal input method: No-voltage input, voltage input, free voltage input
- Screw terminal type (attaching terminal cover)
- LCD display, backlight model
- IP66 protection structure

### Safety Considerations

- Observe all 'Safety Considerations' for safe and proper operation to avoid hazards.
- ⚠ symbol indicates caution due to special circumstances in which hazards may occur.

**⚠ Warning** Failure to follow instructions may result in serious injury or death.

- 01. Fail-safe device must be installed when using the unit with machinery that may cause serious injury or substantial economic loss. (e.g. nuclear power control, medical equipment, ships, vehicles, railways, aircraft, combustion apparatus, safety equipment, crime / disaster prevention devices, etc.)**  
Failure to follow this instruction may result in personal injury, economic loss or fire.
- 02. Do not use the unit in the place where flammable / explosive / corrosive gas, humidity, direct sunlight, radiant heat, vibration, impact, or salinity may be present.**  
Failure to follow this instruction may result in explosion or fire.
- 03. Install on a device panel to use.**  
Failure to follow this instruction may result in fire.
- 04. Do not connect, repair, or inspect the unit while connected to a power source.**  
Failure to follow this instruction may result in fire.
- 05. Check 'Connections' before wiring.**  
Failure to follow this instruction may result in fire.
- 06. Do not disassemble or modify the unit.**  
Failure to follow this instruction may result in fire.
- 07. Since Lithium battery is embedded in the product, do not disassemble or burn the unit.**  
Failure to follow this instruction may result in fire.

**⚠ Caution** Failure to follow instructions may result in injury or product damage.

- 01. When connecting the power / sensor input and relay output, use AWG 20 (0.50 mm<sup>2</sup>) cable or over, and tighten the terminal screw with a tightening torque of 0.74 to 0.90 N m.**  
Failure to follow this instruction may result in fire or malfunction due to contact failure.
- 02. Use the unit within the rated specifications.**  
Failure to follow this instruction may result in fire or product damage.
- 03. Use a dry cloth to clean the unit, and do not use water or organic solvent.**  
Failure to follow this instruction may result in fire.
- 04. Keep the product away from metal chip, dust, and wire residue which flow into the unit.**  
Failure to follow this instruction may result in fire or product damage.

### Cautions during Use

- Follow instructions in 'Cautions during Use'.  
Otherwise, it may cause unexpected accidents.
- When the counter is operating, in case of contact input, set count speed to low speed mode (1 cps, 20 cps, 30 cps) to operate. If set to high speed mode (1 kcps), counting error occurs due to chattering.
- Keep away from high voltage lines or power lines to prevent inductive noise. In case installing power line and input signal line closely, use line filter or varistor at power line and shielded wire at input signal line.  
Do not use near the equipment which generates strong magnetic force or high frequency noise.
- This unit may be used in the following environments.
  - Indoors (in the environment condition rated in 'Specifications')
  - Altitude max. 2,000 m
  - Pollution degree 2
  - Installation category II

## Ordering Information

This is only for reference, the actual product does not support all combinations.  
For selecting the specified model, follow the Autonics website.

**LA8N** - ① - ② - ③

### ① Power

B: Built-in lithium battery

### ② Input method

N: No-voltage input

V: Voltage input

F: Free voltage input

### ③ Backlight

No mark: None

L: Backlight function

## Product Components

- Product (+ bracket)
- Instruction manual

## Dimensions

- Unit: mm, For the detailed drawings, follow the Autonics website.

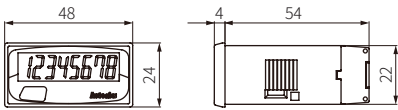

### ■ Bracket

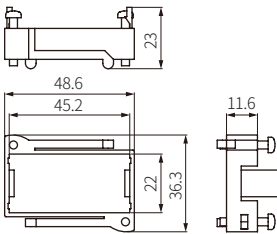

### ■ Panel cut-out

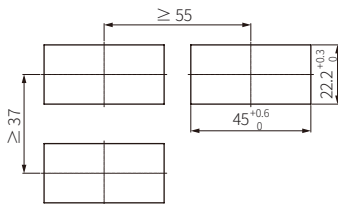

## Connections

Use reliable contacts enough to flow 3 VDC≐ 5 μA of current.

### ■ LA8N-BN

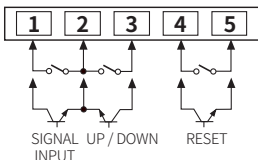

- Terminals no. 2, 5 are connected inside. (non-insulated)

### ■ LA8N-BN-L

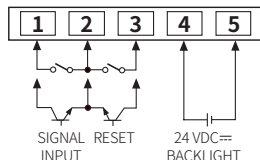

- Terminals no. 1, 2, 3 and no. 4, 5 are insulated inside.

### ■ LA8N-BV

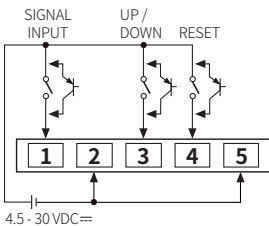

- Terminals no. 2, 5 are connected inside. (non-insulated)

### ■ LA8N-BV-L

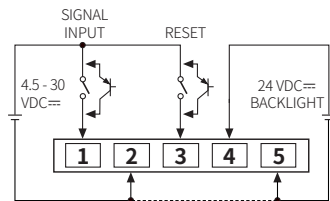

- Terminals no. 1, 2, 3 and no. 4, 5 are insulated inside.
- BACKLIGHT power is available as signal input (SIGNAL INPUT, RESET).

### ■ LA8N-BF

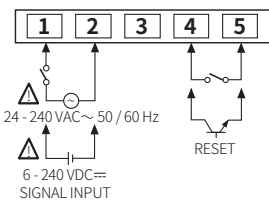

- Terminals no. 1, 2 and no. 4, 5 are insulated inside.

## Specifications

Model	LA8N-BN	LA8N-BN-L	LA8N-BV	LA8N-BV-L	LA8N-BF
Display digits	8-digit				
Display method	LCD Zero Blanking (character size: W 3.4 × H 8.7 mm)				
Max. counting speed	1 cps, 30 cps, 1 kcps				20 cps
Operation method	Count up, count down, count up/down	Count up	Count up, count down, count up/down	Count up	Count up
Counting range	-9999999 to 99999999	0 to 99999999	-9999999 to 99999999	0 to 99999999	0 to 99999999
Input method	No-voltage input		Voltage input		Free voltage input
Counting input (H)	Short Residual voltage: ≤ 0.5 VDC≐ Max. impedance: ≤ 10 kΩ		4.5 - 30 VDC≐		24 - 240 VAC~ / 6 - 240 VDC≐
Counting input (L)	Open Min. impedance: ≥ 750 kΩ		0 - 2 VDC≐		0 - 2 VAC~ / 0 - 2.4 VDC≐
RESET input	No-voltage input		Voltage input		No-voltage input
Min. signal width (UP, DOWN)	≈ 20 ms	-	≈ 20 ms	-	-
Min. signal width (RESET)	≈ 20 ms				
Unit weight (packaged)	≈ 50 g (≈ 96 g)				
Certification	CE, RoHS, REACH, ENEC				

Power supply	Built-in battery (CR2477)
Battery life cycle	≥ 7 years (at ≈ 20 °C)
Backlight power	24 VDC≐ ± 10 %
Insulation resistance	≥ 100 MΩ (500 VDC≐ megger)
Dielectric strength	Between the charging part and the case: 2,000 VAC~ 60 Hz for 1 min
Vibration	0.75 mm double amplitude at frequency of 10 to 55Hz in each X, Y, Z direction for 1 hour
Vibration (malfunction)	0.3 mm double amplitude at frequency of 10 to 55Hz in each X, Y, Z direction for 10 minute
Shock	300 m/s <sup>2</sup> (≈ 30 G) in each X, Y, Z direction for 3 times
Shock (malfunction)	100 m/s <sup>2</sup> (≈ 10 G) in each X, Y, Z direction for 3 times
Ambient temp.	-10 to 55 °C, storage: -25 to 65 °C (no freezing or condensation)
Ambient humi.	35 to 85 %RH, storage: 35 to 85 %RH (no freezing or condensation)
Protection rating	IP66 (front part, when using the rubber waterproof ring, IEC standard)

## Detach the Case

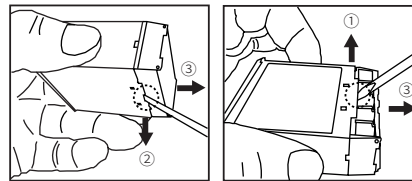

- Hold up Lock part to direction ①, ② that top and bottom of the product with the tools, and pull the terminal to direction ③ to detach the case.

⚠ When using the tools, be careful not to be wounded.

## Replace the Battery

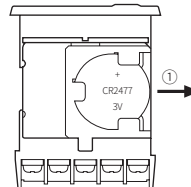

- Detach the case and pull the battery (CR2477) toward direction ① to detach from the product.
- Insert a new battery with the correct alignment of polarity.

## ■ Cautions when using the lithium battery

- Use the battery for the specifications.
- Do not charge, short, disassemble, subject it to shock, heat.
- Check the polarity.
- Do not solder on a battery directly.
- Insulate a battery with tape to dispose.
- Do not store this unit in the place with the direct sunlight, high temperature and humidity.

## DIP Switch Setting

- How to change the settings: power OFF → change settings → power ON → press [RESET] key or input RESET signal ( $\geq 20$  ms) to the external terminal.

### SW1

- Set the enable or disable [RESET] key on the front panel.

Front

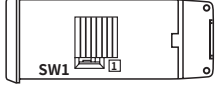

Setting	Use [RESET] key
	Use (defaults)
	Not used

### SW2

- Set the max. counting speed of the no-voltage / voltage input models.

Front



Setting	Max. counting speed
	1 kcps (defaults)
	30 cps
	1 cps

### SW3

- Set the position of decimal point.
- Detach the case first and change the SW3 setting. See the 'Detach the Case.'

Front

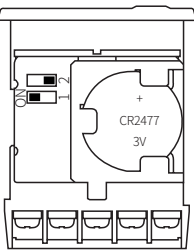

Setting	Decimal point
	0 (defaults)
	0.0
	0.00
	0.000

## Counting Operations

### Count up, count down, count up/down operation

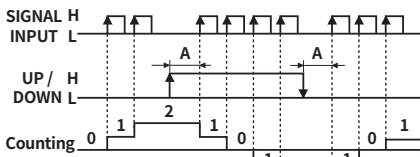

- SIGNAL INPUT: counting input, UP / DOWN: counting command input
- UP / DOWN = in case of L, count up  
UP / DOWN = in case of H, count down
- A should be over 20 ms of width. If A is below that of it, causing a possible counting error.

### Count up operation

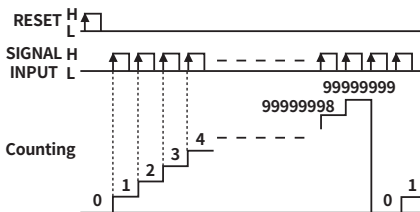

## Input Connections

### No-voltage input

#### Solid-state input

Sensor

(NPN open collector output)

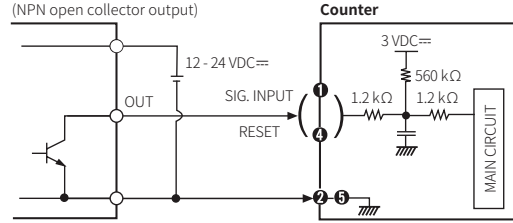

- Do not supply the power to the terminals no. 1, 4.
- The input terminal circuit can be broken, and a malfunction can occur.
- Terminals no. 2, 5 are connected inside.
- For Backlight model, the input terminals are no. 1, 3, and the GND terminal is no. 2.

#### Contact input

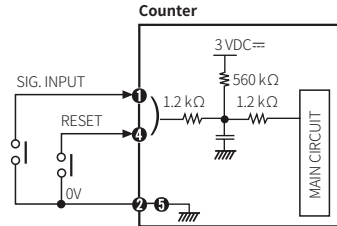

- Use reliable contacts enough to flow 3 VDC  $\approx$  5  $\mu$ A of current.
- For Backlight model, the input terminals are no. 1, 3, and the GND terminal is no. 2.

### Voltage input

#### Solid-state input

Sensor

(PNP open collector output)

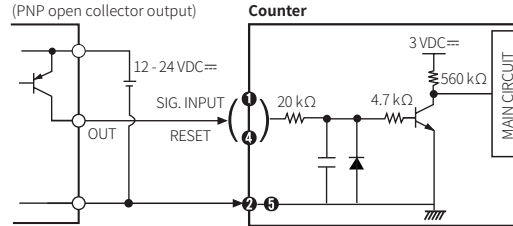

- For Backlight model, the input terminals are no. 1, 3, and the GND terminal is no. 2.

#### Contact input

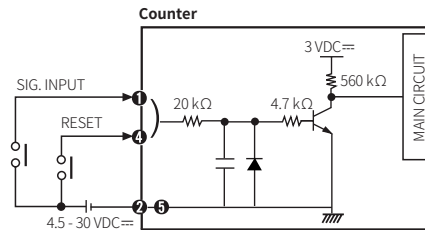

- Use reliable contacts enough to flow 3 VDC  $\approx$  5  $\mu$ A of current.
- For Backlight model, the input terminals are no. 1, 3, and the GND terminal is no. 2.

## ■ Free voltage input

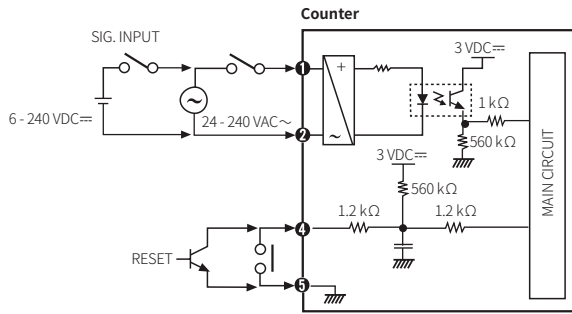

- Input terminals no. 1, 2 and RESET terminals no. 4, 5 are insulated inside.
- It is not possible to RESET with AC power or DC power.
- When relay contact is used as the source of RESET signal, use reliable contacts enough to flow 3 VDC = 5 μA of current.
- Not to use the AC type proximity sensor as an input signal source. Connecting the AC type proximity sensor to the product directly, it will cause malfunction due to leakage current of the proximity sensor. Wire to count by relay contacts with inserting a relay.

