

LCD Digital Timers (Indicator)



LE8N Series PRODUCT MANUAL

For your safety, read and follow the considerations written in the instruction manual, other manuals and Autonics website.

The specifications, dimensions, etc. are subject to change without notice for product improvement. Some models may be discontinued without notice.

Features

- No additional power due to internal battery
- Signal input method: no-voltage input, voltage input, free voltage input
- Screw terminal type (attaching terminal cover)
- LCD display, backlight model
- Protection rating: IP66

Safety Considerations

- Observe all 'Safety Considerations' for safe and proper operation to avoid hazards.
- ⚠ symbol indicates caution due to special circumstances in which hazards may occur.

⚠ Warning Failure to follow instructions may result in serious injury or death.

- 01. Fail-safe device must be installed when using the unit with machinery that may cause serious injury or substantial economic loss. (e.g. nuclear power control, medical equipment, ships, vehicles, railways, aircraft, combustion apparatus, safety equipment, crime/disaster prevention devices, etc.)**
Failure to follow this instruction may result in personal injury, economic loss or fire.
- 02. Do not use the unit in the place where flammable/explosive/corrosive gas, humidity, direct sunlight, radiant heat, vibration, impact, or salinity may be present.**
Failure to follow this instruction may result in explosion or fire.
- 03. Install on a device panel to use.**
Failure to follow this instruction may result in fire.
- 04. Do not connect, repair, or inspect the unit while connected to a power source.**
Failure to follow this instruction may result in fire.
- 05. Check 'Connections' before wiring.**
Failure to follow this instruction may result in fire.
- 06. Do not disassemble or modify the unit.**
Failure to follow this instruction may result in fire.
- 07. Since Lithium battery is embedded in the product, do not disassemble or burn the unit.**
Failure to follow this instruction may result in fire.

⚠ Caution Failure to follow instructions may result in injury or product damage.

- 01. When connecting the power/sensor input and relay output, use AWG 20 (0.50 mm²) cable or over, and tighten the terminal screw with a tightening torque of 0.74 to 0.90 N m.**
Failure to follow this instruction may result in fire or malfunction due to contact failure.
- 02. Use the unit within the rated specifications.**
Failure to follow this instruction may result in fire or product damage.
- 03. Use a dry cloth to clean the unit, and do not use water or organic solvent.**
Failure to follow this instruction may result in fire.
- 04. Keep the product away from metal chip, dust, and wire residue which flow into the unit.**
Failure to follow this instruction may result in fire or product damage.

Cautions during Use

- Follow instructions in 'Cautions during Use'. Otherwise, it may cause unexpected accidents.
- Keep away from high voltage lines or power lines to prevent inductive noise. In case installing power line and input signal line closely, use line filter or varistor at power line and shielded wire at input signal line.
Do not use near the equipment which generates strong magnetic force or high frequency noise.
- This unit may be used in the following environments.
 - Indoors (in the environment condition rated in 'Specifications')
 - Altitude max. 2,000 m
 - Pollution degree 2
 - Installation category II

Ordering Information

This is only for reference, the actual product does not support all combinations.
For selecting the specified model, follow the Autonics website.

LE8N - ① - ② - ③

① Power

B: Built-in lithium battery

② Input method

N: no-voltage input

V: voltage input

F: free voltage input

③ Backlight

No-mark: none

L: Backlight function

Product Components

- Product (+ bracket, rubber waterproof ring)
- Instruction manual

Dimensions

• Unit: mm, For the detailed drawings, follow the Autonics website.

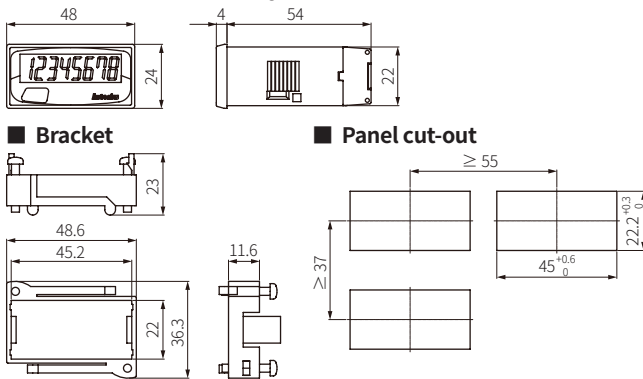

Connections

Use reliable contacts enough to flow 3 VDC \approx 5 μ A of current.

LE8N-BN

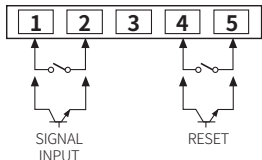

- Terminals no. 2, 5 are connected inside. (non-insulated)

LE8N-BN-L

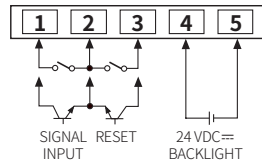

- Terminals no. 1, 2, 3 and no. 4, 5 are insulated inside.

LE8N-BV

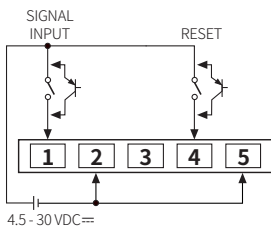

- Terminals no. 2, 5 are connected inside. (non-insulated)

LE8N-BV-L

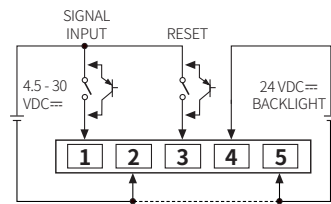

- Terminals no. 1, 2, 3 and no. 4, 5 are insulated inside.
- BACKLIGHT power is available as signal input (SIGNAL INPUT, RESET).

LE8N-BF

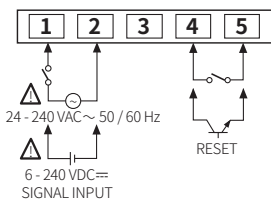

- Terminals no. 1, 2 and no. 4, 5 are insulated inside.

Specifications

Model	LE8N-BN	LE8N-BN-L	LE8N-BV	LE8N-BV-L	LE8N-BF
Display digits	8-digit				
Display method	LCD Zero Blanking (character size: W 3.4 × H 8.7 mm)				
Operation method	Count up				
Time range	0 to 99999999				
Error	Time / Temp.: \pm 0.01%				
Input method	No-voltage input	Voltage input		Free voltage input	
Counting input (H)	Short Residual voltage: \leq 0.5 VDC \approx Max impedance: \leq 10 k Ω	4.5 - 30 VDC \approx		24 - 240 VAC \sim / 6 - 240 VDC \approx	
Counting input (L)	Open Min. impedance: \geq 750 k Ω	0 - 2 VDC \approx		0 - 2 VAC \sim / 0 - 2.4 VDC \approx	
RESET input	No-voltage input	Voltage input		No-voltage input	
Min. signal width	SIGNAL INPUT, RESET: \geq 20 ms				
Unit weight (packaged)	\approx 50 g (\approx 96 g)				
Certification	CE UK & EU ENEC				

Power supply	Built-in battery (CR2477)
Battery life cycle	\geq 10 years (at \approx 20 °C)
Backlight power	24 VDC \approx \pm 10%
Insulation resistance	\geq 100 M Ω (500 VDC \approx megger)
Dielectric strength	Between the charging part and the case: 2,000 VAC \sim at 50 / 60 Hz for 1 min
Vibration	0.75 mm double amplitude at frequency of 10 to 55Hz in each X, Y, Z direction for 1 hour
Vibration (malfunction)	0.5 mm double amplitude at frequency of 10 to 55Hz in each X, Y, Z direction for 10 min
Shock	300 m/s ² (\approx 30 G) in each X, Y, Z direction for 3 times
Shock (malfunction)	100 m/s ² (\approx 10 G) in each X, Y, Z direction for 3 times
Ambient temperature	-10 to 55 °C, storage: -25 to 65 °C (no freezing or condensation)
Ambient humidity	35 to 85%RH, storage: 35 to 85%RH (no freezing or condensation)
Protection rating	IP66 (front part, when using the rubber waterproof ring, IEC standard)

Detach the Case

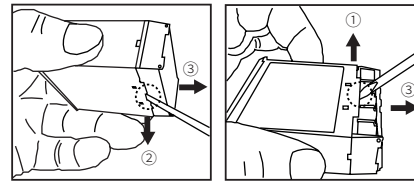

- Hold up Lock part to direction ①, ② that top and bottom of the product with the tools, and pull the terminal to direction ③ to detach the case.

⚠ When using the tools, be careful not to be wounded.

Replace the Battery

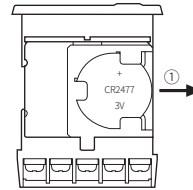

- Detach the case and pull the battery (CR2477) toward direction ① to detach from the product.
- Insert a new battery with the correct alignment of polarity.

■ Cautions when using the lithium battery

- Do not charge, short, disassemble, subject it to shock, heat.
- Check the polarity.
- Do not solder on a battery directly.
- Insulate a battery with tape to dispose.
- Do not store this unit in the place with the direct sunlight, high temperature and humidity.

DIP Switch Setting

- How to change the settings: power OFF → change settings → power ON → press [RESET] key or input RESET signal (≥ 20 ms) to the external terminal.

SW1

- Set the enable or disable [RESET] key on the front panel.

Front

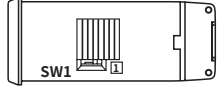

Setting	Use [RESET] key
1	Use (defaults)
1	Not used

SW2, SW3

- Set the time range.
- Detach the case first and change the SW3 setting. Refer to the 'Detach the Case.'

[SW2]



[SW3]

Front

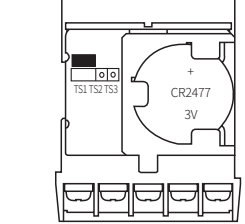

SW2 \ SW3	SW3		
	TS1	TS2	TS3
1	hour min 999999.59 (defaults)	sec 99999999	hour 999999.9h
2	hour min 99999.59.9	day hour 9999d23.9	hour min 99999h59
3	hour min sec 9999.59.59	day hour min 9999.23.59	hour min 9999h59.9

Time Operation

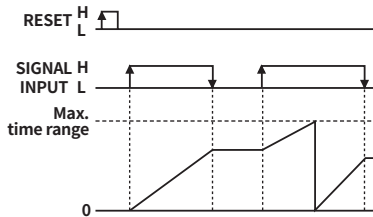

Input Connections

No-voltage input

Solid-state input

Sensor

(NPN open collector output)

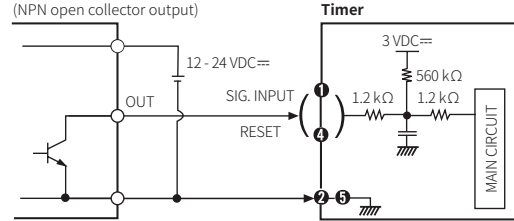

- Do not supply the power to the terminals no. 1, 4.
- The input terminal circuit can be broken, and a malfunction can occur.
- Terminals no. 2, 5 are connected inside.
- For Backlight model, the input terminals are no. 1, 3, and the GND terminal is no. 2.

Contact input

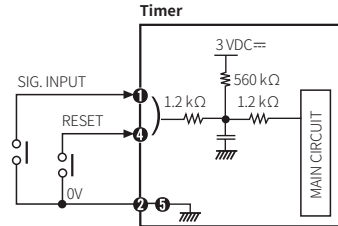

- Use reliable contacts enough to flow 3 VDC = 5 μ A of current.
- For Backlight model, the input terminals are no. 1, 3, and the GND terminal is no. 2.

Voltage input

Solid-state input

Sensor

(PNP open collector output)

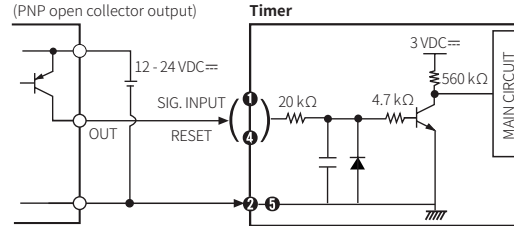

- For Backlight model, the input terminals are no. 1, 3, and the GND terminal is no. 2.

Contact input

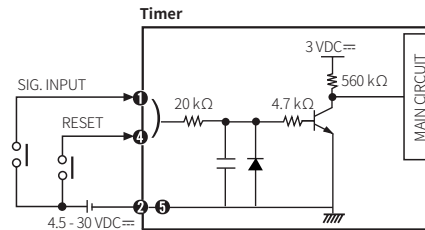

- Use reliable contacts enough to flow 3 VDC = 5 μ A of current.
- For Backlight model, the input terminals are no. 1, 3, and the GND terminal is no. 2.

■ Free voltage input

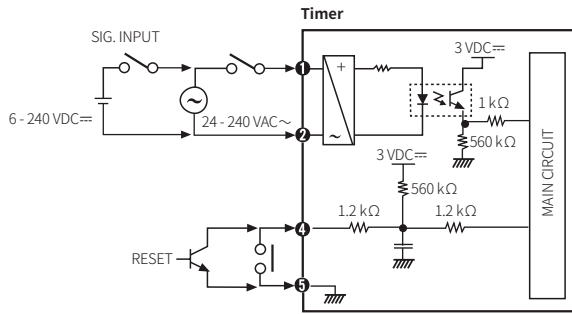

- Input terminals no. 1, 2 and RESET terminals no. 4, 5 are insulated inside.
- It is not possible to RESET with AC power or DC power.
- When relay contact is used as the source of RESET signal, use reliable contacts enough to flow 3 VDC = 5 μ A of current.
- Not to use the AC type proximity sensor as an input signal source.
Connecting the AC type proximity sensor to the product directly, it will cause malfunction due to leakage current of the proximity sensor. Wire to count by relay contacts with inserting a relay.

