

Digital Counters / Timers (Indicator)



FX4Y Series PRODUCT MANUAL

For your safety, read and follow the considerations written in the instruction manual, other manuals and Autonics website.

The specifications, dimensions, etc. are subject to change without notice for product improvement. Some models may be discontinued without notice.

Features

- Counting speeds: 1 cps / 30 cps / 2 kcps / 5 kcps
- Switch between counter and timer operation using DIP switch
- Switch between voltage input (PNP) and no-voltage input (PNP) using DIP switch
- Set decimal point, hr / min / sec display with RESET key
- Operation modes: count-up, count-down, count-up / down (counter)

[Counter]

- 20 input modes

[Timer]

- Various time setting ranges
 - 6-digit models: 0.01 sec to 99999.9 hr
 - 4-digit models: 0.01 sec to 9999 hr
- Power supply
 - 100 - 240 VAC ~ 50 / 60 Hz (AC type)
 - 24 VAC ~ 50 / 60 Hz, 24 - 48 VDC = (AC / DC universal type)

Safety Considerations

- Observe all 'Safety Considerations' for safe and proper operation to avoid hazards.
- ⚠ symbol indicates caution due to special circumstances in which hazards may occur.

⚠ Warning Failure to follow instructions may result in serious injury or death.

- 01. Fail-safe device must be installed when using the unit with machinery that may cause serious injury or substantial economic loss. (e.g. nuclear power control, medical equipment, ships, vehicles, railways, aircraft, combustion apparatus, safety equipment, crime / disaster prevention devices, etc.)**
Failure to follow this instruction may result in personal injury, economic loss or fire.
- 02. Do not use the unit in the place where flammable / explosive / corrosive gas, humidity, direct sunlight, radiant heat, vibration, impact, or salinity may be present.**
Failure to follow this instruction may result in explosion or fire.
- 03. Install on a device panel to use.**
Failure to follow this instruction may result in fire or electric shock.
- 04. Do not connect, repair, or inspect the unit while connected to a power source.**
Failure to follow this instruction may result in fire or electric shock.
- 05. Check 'Connections' before wiring.**
Failure to follow this instruction may result in fire.
- 06. Do not disassemble or modify the unit.**
Failure to follow this instruction may result in fire or electric shock.

⚠ Caution Failure to follow instructions may result in injury or product damage.

- 01. When connecting the power / sensor input, use AWG 20 (0.50 mm²) cable or over, and tighten the terminal screw with a tightening torque of 0.74 to 0.90 N m.**
Failure to follow this instruction may result in fire or malfunction due to contact failure.
- 02. Use the unit within the rated specifications.**
Failure to follow this instruction may result in fire or product damage.
- 03. Use a dry cloth to clean the unit, and do not use water or organic solvent.**
Failure to follow this instruction may result in fire or electric shock.
- 04. Keep the product away from metal chip, dust, and wire residue which flow into the unit.**
Failure to follow this instruction may result in fire or product damage.

Cautions during Use

- Follow instructions in 'Cautions during Use'.
Otherwise, it may cause unexpected accidents.
- Power supply should be insulated and limited voltage / current or Class 2, SELV power supply device.
- Use the product, 0.1 sec after supplying power.
- When supplying or turning off the power, use a switch or etc. to avoid chattering.
- Install a power switch or circuit breaker in the easily accessible place for supplying or disconnecting the power.
- When the counter is operating, in case of contact input, set count speed to low speed mode (1 cps or 30 cps) to operate. If set to high speed mode (2 k, 5 kcps) counting error occurs due to chattering.
- Keep away from high voltage lines or power lines to prevent inductive noise. In case installing power line and input signal line closely, use line filter or varistor at power line and shielded wire at input signal line.
Do not use near the equipment which generates strong magnetic force or high frequency noise.
- This unit may be used in the following environments.
 - Indoors (in the environment condition rated in 'Specifications')
 - Altitude max. 2,000 m
 - Pollution degree 2
 - Installation category II

Ordering Information

This is only for reference, the actual product does not support all combinations.
For selecting the specified model, follow the Autonics website.

FX **1** **2** - **3** **4**

1 Display digits

4: 4-digit
6: 6-digit

2 Size

Y: DIN W 72 × H 36 mm

3 Output

I: Indicator

4 Power supply

2: 24 VAC ± 10 % 50 / 60 Hz,
24 - 48 VDC ± 10 %
4: 100 - 240 VAC ± 10 % 50 / 60 Hz

Product Components

- Product
- Bracket × 2
- Instruction manual

Sold Separately

- Terminal protection cover: M7P-COVER

Dimensions

- Unit: mm, For the detailed drawings, follow the Autonics website.

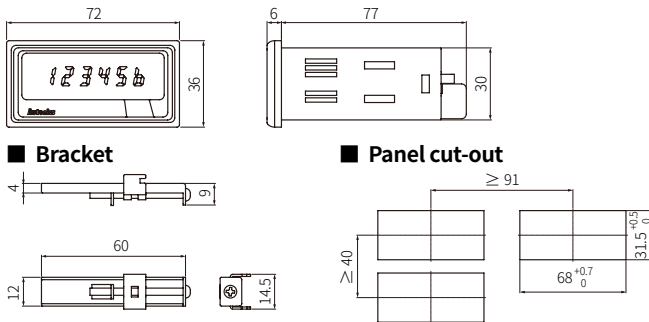

Connections

FX□Y-I4

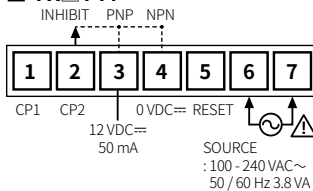

FX□Y-I2

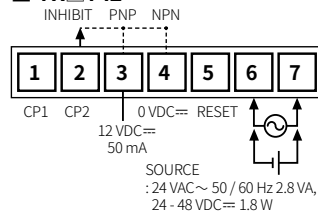

- INHIBIT: In case of timer mode, this terminal is for time hold.
- Voltage input (PNP): connect with 12 VDC
- No-voltage input (NPN): connect with 0 VDC

Specifications

Model	FX4Y-I□	FX6Y-I□
Display digits	4-digit	6-digit
Character size	W 8 × H 14 mm	W 4 × H 8 mm
Max. counting speed	1 / 30 / 2 k / 5 k cps	
Return time	≤ 500 ms	
Min. signal width	INHIBIT, RESET: ≈ 20 ms	
Input logic	Voltage input (PNP) - input impedance: ≤ 10.8 kΩ, [H]: 5 - 30 VDC, [L]: 0 - 2 VDC No-voltage input (NPN) - short-circuit impedance: ≤ 470 Ω, short-circuit residual voltage: ≤ 1 VDC open-circuit impedance: ≥ 100 kΩ	
Error	Repeat / SET / voltage / Temp.: ≤ ± 0.01 % ± 0.05 s	
Unit weight (packaged)	≈ 120 g (≈ 175 g)	
Certification	CE, RoHS, ENEC, ETL	

Voltage type	AC voltage	AC / DC voltage
Power supply	100 - 240 VAC ~ 50 / 60 Hz	24 VAC ~ 50 / 60 Hz, 24 - 48 VDC
Permissible voltage range	90 to 110 % of rated voltage	
Power consumption	≤ 3.8 VA	AC: ≤ 2.8 VA DC: ≤ 1.8 W
External supply power	≤ 12 VDC ± 10 % 50 mA	
Memory retention	≈ 10 years (non-volatile semiconductor memory type)	
Insulation resistance	≥ 100 MΩ (500 VDC megger)	
Dielectric strength	Between the charging part and the case : 3,000 VAC ~ 50 / 60 Hz for 1 min	Between the charging part and the case : 2,000 VAC ~ 50 / 60 Hz for 1 min
Noise immunity	± 2 kV square wave noise (pulse width: 1 μs) by the noise simulator	± 500 V square wave noise (pulse width: 1 μs) by the noise simulator
Vibration	0.75 mm double amplitude at frequency of 10 to 55 Hz in each X, Y, Z direction for 1 hour	
Vibration (malfunction)	0.5 mm double amplitude at frequency of 10 to 55 Hz in each X, Y, Z direction for 10 minute	
Shock	300 m/s ² (≈ 30 G) in each X, Y, Z direction for 3 times	
Shock (malfunction)	100 m/s ² (≈ 10 G) in each X, Y, Z direction for 3 times	
Ambient temperature	-10 to 55 °C, storage: -25 to 65 °C (no freezing or condensation)	
Ambient humidity	35 to 85 %RH, storage: 35 to 85 %RH (no freezing or condensation)	
Protection rating	IP40 (front part, IEC standard)	

Mode Setting



Dot for Decimal Point & Hour / Min / Second

- If there is no RESET key or DIP switch input for 60 sec, it returns to RUN mode.
- [RESET] key: Setting mode ↔ RUN mode
Move the digit when changing the setting value.

Decimal point of counter

Parameter	Display	Setting range
C1-1 Setting mode	dP	-
C1-2 Decimal point setting	----	[FX4Y-I□] ----, --, -, -
	-----	[FX6Y-I□] -----, ----, ---, --, -, -

Dot for Hour / Min / Second of timer

Parameter	Display	Setting range	Setting example
T1-1 Setting mode	dP	-	-
T1-2 Setting of dot for Hour / Min / Sec	CLr	CLR: Not divided with dot SET: Divided with dot	5959: 59 m 59 s 0.59.59: 59 m 59 s

Detach the Case

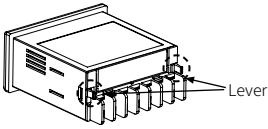

- Press the both levers and pull them from the front to detach the case and the terminal. DIP switch is located inside.
- Caution: Turn OFF the power before detaching the case.**

DIP Switch Setting



- Detach the case and proceed the settings. See the 'Detach the Case.'
- How to change the settings:
power OFF → change settings → power ON → press [RESET] key or input the RESET signal (≥ 20 ms) to the external terminal.

SW	Function		Defaults
	Counter	Timer	
1	-	Time range	OFF
2	Input operation mode		OFF
3			OFF
4	Count up / count down	OFF	
5	Max. counting speed	-	OFF
6			OFF
7	Front [RESET] key	ON	
8	Memory retention	OFF	
9	Counter / Timer	ON	
10	CP1, CP2, INHIBIT, RESET input logic	ON	

[Counter] Input operation mode

SW 2	SW 3	SW 4	Count up / count down & input operation mode		
			Count up	Count down	
OFF	OFF	OFF	Up / Down - A (command)	Count up	
ON	OFF	OFF	Up / Down - B (individual)		
OFF	ON	OFF	Up / Down - C (phase difference)		
ON	ON	OFF	UP		
OFF	OFF	ON	Up / Down - D (command)		Count down
ON	OFF	ON	Up / Down - E (individual)		
OFF	ON	ON	Up / Down - F (phase difference)		
ON	ON	ON	Down		

[Counter] Max. counting speed

SW 5	SW 6	Max. counting speed
ON	OFF	1 cps
OFF	OFF	30 cps
OFF	ON	2 kcps
ON	ON	5 kcps

Front [RESET] key

SW-7	Front [RESET] key
ON	Use
OFF	Not used

Counter / Timer

SW-9	Counter / Timer
ON	Counter
OFF	Timer

[Timer] Time range

SW 1	SW 2	SW 3	Time range	
			4-digit	6-digit
OFF	OFF	OFF	99.99 s	99999.9 s
ON	OFF	OFF	999.9 s	999999 s
OFF	ON	OFF	9999 s	99 m 59.99 s
ON	ON	OFF	99 m 59 s	999 m 59.9 s
OFF	OFF	ON	999.9 m	99999.9 m
ON	OFF	ON	99 h 59 m	99 h 59 m 59 s
OFF	ON	ON	999.9 h	9999 h 59 m
ON	ON	ON	9999 h	99999.9 h

Memory retention

SW-8	Memory retention
ON	×
OFF	○

Input logic

SW-10	Input logic
ON	NPN (no-voltage input)
OFF	PNP (voltage input)

Sold Separately: Terminal Protection Cover

- Unit: mm

M7P-COVER

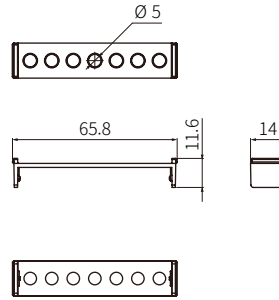

Input Connections

- Input: CP1, CP2 (INHIBIT), RESET
- Max. counting speed in the contact input: 1 or 30 cps setting (counter).

No-voltage (NPN) input

Solid-state input

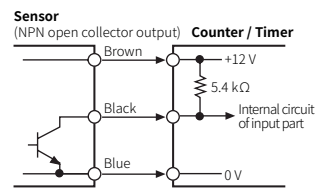
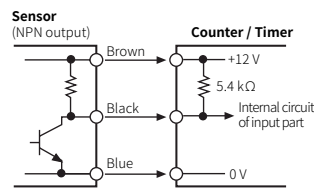

Contact input

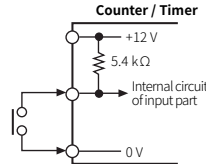

Voltage (PNP) input

Solid-state input

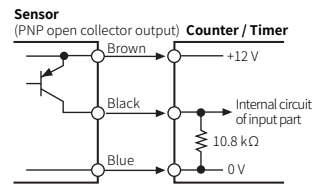
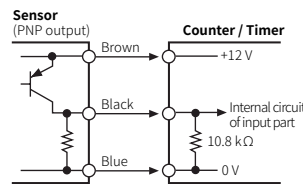

Contact input

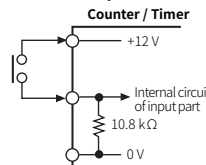

Counter Operation

Input operation mode

Mode	Counting chart ⁰¹⁾	
	Voltage input (PNP)	No-voltage input (NPN)
Up / Down - A : command input		
Up / Down - B : individual input		
Up / Down - C : phase difference input		
Up : count up input		
Up / Down - D : command input		
Up / Down - E : individual input		
Up / Down - F : phase difference input		
Down : count down input		

01) CP: clock pulse, n: +max. display value
A should be over min. signal width, B is over 1/2 of min. signal width. If the signal is smaller than these widths, it may cause counting error (± 1).

Counting operation

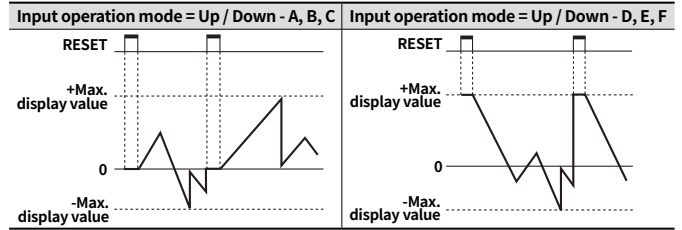
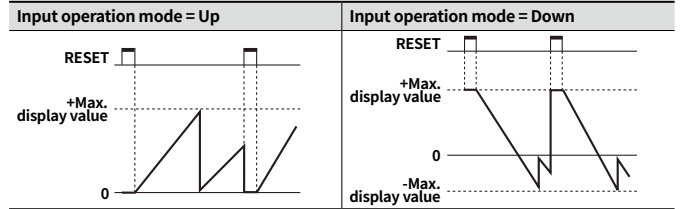

Timer Operation

Time operation

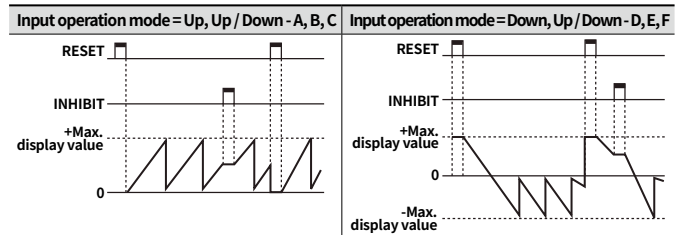

Segment Table

The segments displayed on the product indicate the following meanings. It may differ depending on the product.

7 segment				11 segment				12 segment				16 segment			
0	0	l	l	0	0	l	l	0	0	l	l	0	0	l	l
1	1	U	J	1	1	U	J	1	1	U	J	1	1	U	J
2	2	E	K	2	2	E	K	2	2	E	K	2	2	E	K
3	3	L	L	3	3	L	L	3	3	L	L	3	3	L	L
4	4	n	M	4	4	n	M	4	4	n	M	4	4	n	M
5	5	n	N	5	5	n	N	5	5	n	N	5	5	n	N
6	6	o	O	6	6	o	O	6	6	o	O	6	6	o	O
7	7	P	P	7	7	P	P	7	7	P	P	7	7	P	P
8	8	q	Q	8	8	q	Q	8	8	q	Q	8	8	q	Q
9	9	r	R	9	9	r	R	9	9	r	R	9	9	r	R
A	A	S	S	A	A	S	S	A	A	S	S	A	A	S	S
b	B	t	T	b	B	t	T	b	B	t	T	b	B	t	T
c	C	U	U	c	C	U	U	c	C	U	U	c	C	U	U
d	D	v	V	d	D	v	V	d	D	v	V	d	D	v	V
E	E	w	W	E	E	w	W	E	E	w	W	E	E	w	W
F	F	x	X	F	F	x	X	F	F	x	X	F	F	x	X
G	G	y	Y	G	G	y	Y	G	G	y	Y	G	G	y	Y
H	H	z	Z	H	H	z	Z	H	H	z	Z	H	H	z	Z