

# Retroreflective Type Fiber Optic Units

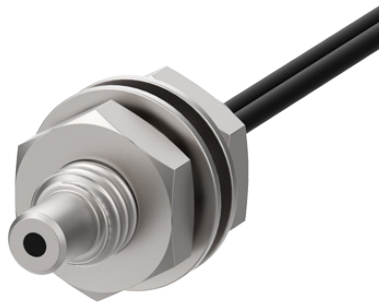

## FD/GD Series PRODUCT MANUAL

For your safety, read and follow the considerations written in the instruction manual, other manuals and Autonics website.

The specifications, dimensions, etc. are subject to change without notice for product improvement. Some models may be discontinued without notice.

### Icon Overview

- Std.** Standard:  
Fiber optic units for general purpose
- Heat-resistant:  
Fiber optic units for the high-temperature environment (-60 to 350°C)
- Vacuum-resistant:  
Fiber optic units for the high-temperature (-60 to 250°C) and vacuum environment
- Bending-resistant (R5):  
Fiber optic units for withstanding repeated bending
- Flexible (R1, R2):  
Fiber optic units for withstanding repeated flexing

### Retroreflective Type Line Up

Head shape	Standard	Heat-resistant	Vacuum-resistant	Bending-resistant	Flexible
Threaded head	Std.				
Cylindrical head	Std.				
Flat head					
L-shaped head					
Molded plastic head	Std.				
Perp. head					
SUS head	Std.				
Wide area head					

### Selection Guide

△ The installation method for the fiber optic units may vary depending on the fiber optic amplifiers. Be sure to refer to the 'Product manual' of the amplifiers you are using. For detailed information on the fiber optic units, refer to the 'Fiber optic sensor guide'.

#### 00. When using the vacuum-resistant fibers

Be sure to connect with the vacuum-resistant fiber, the fiber optic coupler, and the atmospheric side fiber.

#### 01. Model name

The model name starting with 'F' indicates plastic-type optical fibers, while starting with 'G' indicates glass-type optical fibers.

#### 02. Minimum target size

The minimum detectable target came out with the maximum sensitivity setting of the BF4 series.

#### 03. Sensing distance

The sensing distance of the optical fibers varies depending on the testing environments of each amplifier. Apply 10% of the BF4R□-□ sensing distance to the fiber optic amplifiers BF4G□-□ model.

Errors in the sensing distance may occur due to the sensing environment as below.

- Fiber optic units: Bend radius of cable, condition of cutting surface, amplifier insertion depth, etc.
- Detectable objects: Material, shape or inclination, bending, gloss, etc.

#### 04. FREE CUT

Be sure to cut the cable using the provided fiber cutter (FC-3) for FREE CUT type models.

#### 05. Adapter

Be sure to connect the provided adapter for the adapter-compatible models. When checking the product components or ordering the sold separately, refer to the marks below.

- : It is possible to use the Product Components and the adapter (sold separately).
- : Only the adapter included with the product is available and cannot be purchased separately.
- : The adapter is not supported.

#### 06. Dimensions

For detailed information on the drawings and dimensions, follow the Autonics website.







### Product Components

- Fiber optic units
- Fiber cutter (for FREE CUT type model)
- Adapter (for Adapter-compatible model)

### Sold Separately

- Included items for the vacuum-resistant fiber
  - Fiber optic coupler: FU-VC□
  - Atmospheric side fiber: FU-VA□
- Lens unit for a micro spot: FDC-2
- Fiber cutter: FC-3
- Cable protection tube: FDH-□□
- Adapter

## Threaded head: Standard

Appearance	Model	Cable		Ambient temperature	Min. target size	Sensing distance (unit: mm)					Adapter
		Length	Bend radius			Mode \ Amp.	BFX-D1-□	BF5R-□1-□	BF4R-□-□ <sup>01)</sup>	BF3RX-□ <sup>01)</sup>	
	FD-310-05	1 m (FREE CUT)	R15	-40 to 70 °C	Ø 0.03 mm	U-FST	15	15			●
						FAST	20	25			
						STD	40	50			
						LONG	90	115			
						U-LG / MAX.	185	220	40	30	
	FD-320-05	2 m (FREE CUT)	R15	-40 to 70 °C	Ø 0.03 mm	U-FST	10	10			●
						FAST	20	15			
						STD	25	30			
						LONG	65	70			
						U-LG / MAX.	140	105	40	35	
	FD-420-05	2 m (FREE CUT)	R15	-40 to 70 °C	Ø 0.03 mm	U-FST	15	15			●
						FAST	20	25			
						STD	40	55			
						LONG	80	100			
						U-LG / MAX.	110	140	40	5	
	FD-620-10	2 m (FREE CUT)	R25	-40 to 70 °C	Ø 0.03 mm	U-FST	70	80			-
						FAST	105	120			
						STD	180	255			
						LONG	345	405			
						U-LG / MAX.	460	525	120	20	
	FD-320-F	2 m (FREE CUT)	R10	-40 to 70 °C	Ø 0.03 mm	U-FST	15	20			●
						FAST	20	30			
						STD	40	60			
						LONG	95	120			
						U-LG / MAX.	140	170	40	40	
	FD-320-F1	2 m (FREE CUT)	R10	-40 to 70 °C	Ø 0.03 mm	U-FST	20	25			●
						FAST	40	45			
						STD	60	95			
						LONG	140	175			
						U-LG / MAX.	220	250	60	20	
	FD-620-F2	2 m (FREE CUT)	R30	-40 to 70 °C	Ø 0.03 mm	U-FST	75	80			-
						FAST	110	140			
						STD	185	275			
						LONG	355	470			
						U-LG / MAX.	495	660	120	20	

01) When setting the maximum sensitivity for each amplifier.

## ■ Dimensions

• Unit: mm, For the detailed drawings, follow the Autonics website.

### • FD-310-05

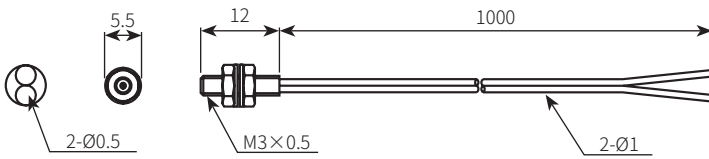

### • FD-320-05

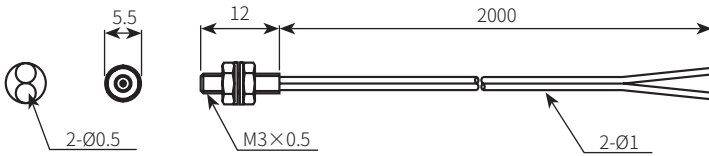

### • FD-420-05

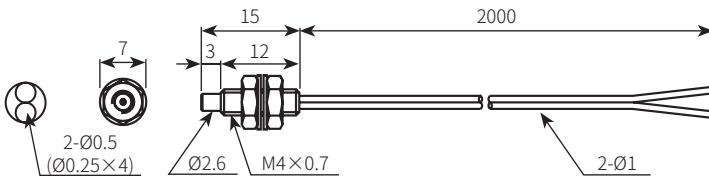

### • FD-620-10

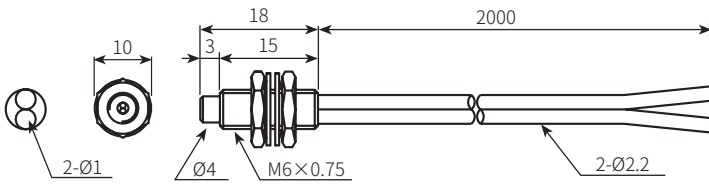

### • FD-320-F

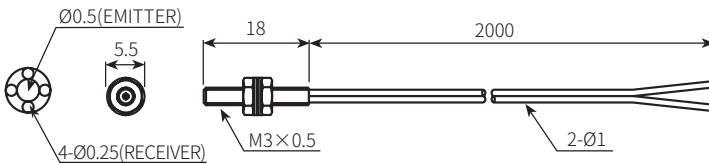

### • FD-320-F1



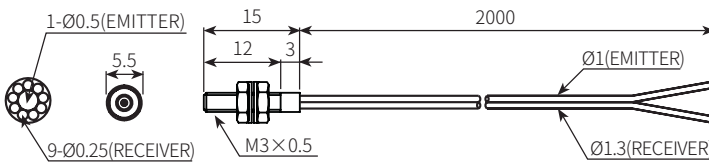

Be sure not to change the cable of the EMITTER/RECEIVER when mounting to the amplifier.  
The adapter of emitter (black), the adapter of receiver (dark gray)

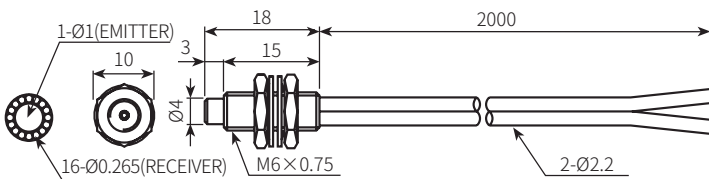

### • FD-620-F2



## Threaded head: Heat-resistant

Appearance	Model	Cable		Ambient temperature	Min. target size	Sensing distance (unit: mm)				Adapter	
		Length	Bend radius			Mode \ Amp.	BFX-D1-□	BF5R-□1-□	BF4R□-□ <sup>01)</sup>		BF3RX-□ <sup>01)</sup>
	FD-620-10H	2 m (FREE CUT)	R25	-40 to 105 °C	Ø 0.08 mm	U-FST	75	80			-
						FAST	115	130			
						STD	170	300			
						LONG	300	430			
						U-LG / MAX.	520	500	200	185	
	FD-620-15H1	2 m (FREE CUT)	R35	-40 to 150 °C	Ø 0.08 mm	U-FST	80	85			-
						FAST	115	135			
						STD	175	275			
						LONG	340	425			
						U-LG / MAX.	440	555	165	150	
	GD-420-20H2	2 m	R25	-40 to 250 °C	Ø 0.08 mm	U-FST	70	95			-
						FAST	110	160			
						STD	175	330			
						LONG	325	540			
						U-LG / MAX.	495	745	180	N.A	
	GD-620-20H2	2 m	R25	-40 to 250 °C	Ø 0.08 mm	U-FST	75	85			-
						FAST	110	140			
						STD	175	300			
						LONG	340	470			
						U-LG / MAX.	440	620	195	N.A	
	GD-620-12H3	2 m	R25	-60 to 350 °C	Ø 0.08 mm	U-FST	80	90			-
						FAST	115	150			
						STD	180	270			
						LONG	320	420			
						U-LG / MAX.	450	580	190	N.A	

01) When setting the maximum sensitivity for each amplifier.

■ Dimensions

• Unit: mm, For the detailed drawings, follow the Autonics website.

• FD-620-10H

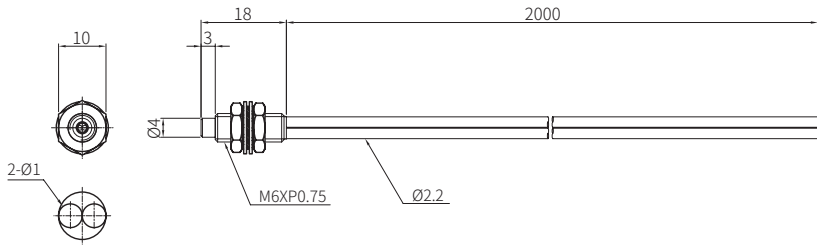

• FD-620-15H1

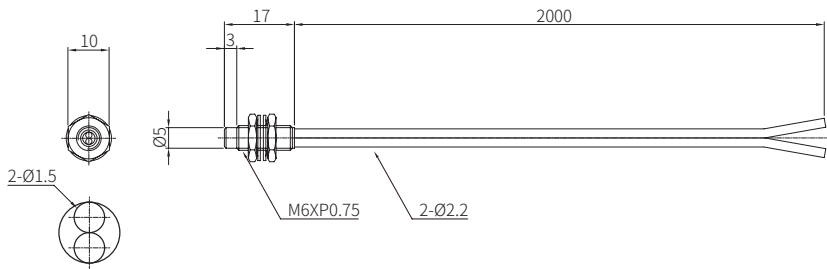

• GD-420-20H2

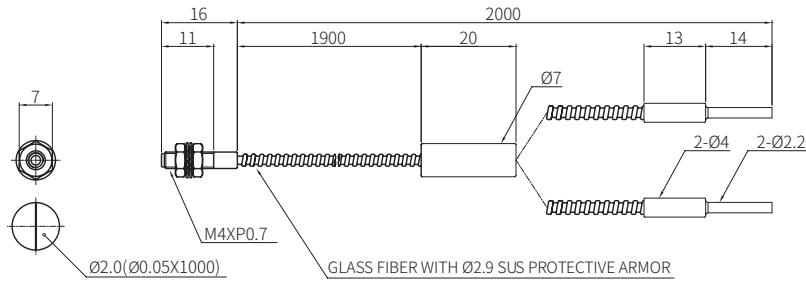

• GD-620-20H2

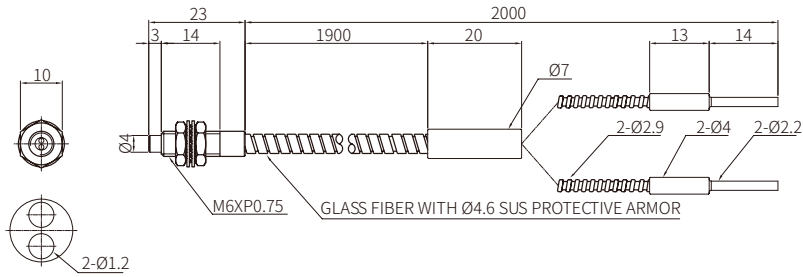

• GD-620-12H3

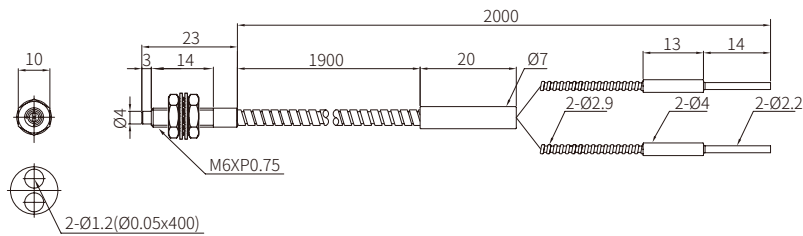

## Threaded head: Vacuum-resistant

- Be sure to connect with the vacuum-resistant fiber, the fiber optic coupler, and the atmospheric side fiber.
- The sensing distance of the vacuum-resistant fiber unit is based on the installation of the atmospheric side fiber unit (FU-VA0□, sold separately).

Appearance	Model	Cable		Ambient temperature	Min. target size	Sensing distance (unit: mm)				Adapter		
		Length	Bend radius			Mode	Amp.	BFX-D1-□	BF5R-□1-□		BF4R□-□ <sup>01)</sup>	BF3RX-□ <sup>01)</sup>
	GD-610-12V2	1 m	R25	-60 to 250 °C	Ø 0.08 mm (+ FU-VA01)	U-FST		20	60			
						FAST		30	90			
						STD		55	180			
						LONG		100	290			
						U-LG / MAX.		230	380	95	80	
					U-FST		10	40				
					FAST		20	60				
					STD		35	120				
					LONG		80	230				
					U-LG / MAX.		160	310	70	60		

01) When setting the maximum sensitivity for each amplifier.



### ■ Dimensions

- Unit: mm, For the detailed drawings, follow the Autonics website.

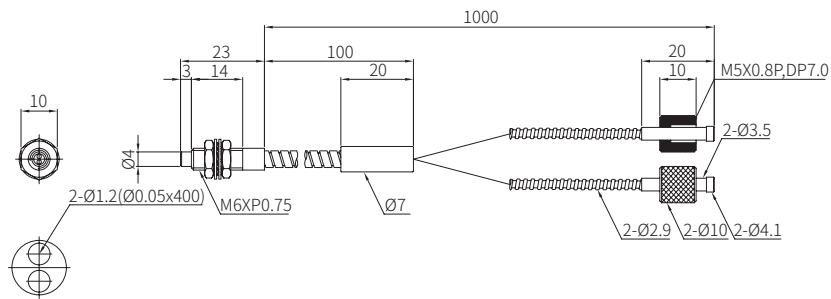
#### • GD-610-12V2



## Threaded head: Bending-resistant

Appearance	Model	Cable		Ambient temperature	Min. target size	Sensing distance (unit: mm)				Adapter	
		Length	Bend radius			Mode \ Amp.	BFX-D1-□	BF5R-□1-□	BF4R□-□ <sup>01)</sup>		BF3RX-□ <sup>01)</sup>
	FD-320-06B	2 m (FREE CUT)	R5	-40 to 60 °C	Ø 0.0125 mm	U-FST	15	15	-	-	●
						FAST	20	25			
						STD	35	55			
						LONG	80	100			
						U-LG / MAX.	105	145			
	FD-420-06B	2 m (FREE CUT)	R5	-40 to 60 °C	Ø 0.0125 mm	U-FST	15	15	-	-	●
						FAST	20	25			
						STD	40	60			
						LONG	85	100			
						U-LG / MAX.	115	145			
	FD-620-13B	2 m	R5	-40 to 60 °C	Ø 0.0125 mm	U-FST	40	25	-	-	-
						FAST	60	40			
						STD	105	80			
						LONG	230	315			
						U-LG / MAX.	320	410			

01) When setting the maximum sensitivity for each amplifier.

### ■ Dimensions

• Unit: mm, For the detailed drawings, follow the Autonics website.

#### • FD-320-06B

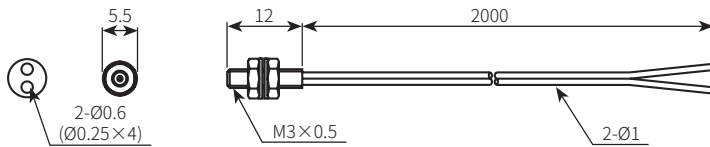

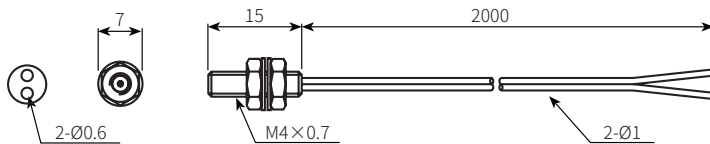

#### • FD-420-06B

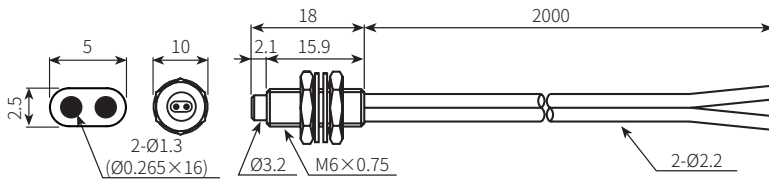

#### • FD-620-13B



## Threaded head: Flexible

Appearance	Model	Cable		Ambient temperature	Min. target size	Sensing distance (unit: mm)				Adapter		
		Length	Bend radius			Mode	Amp.	BFX-D1-□	BF5R-□1-□		BF4R□-□ <sup>01)</sup>	BF3RX-□ <sup>01)</sup>
	FD-320-05R	2 m (FREE CUT)	R1	-40 to 60 °C	Ø 0.0125 mm	U-FST		10	5			●
						FAST		15	15			
						STD		25	35			
						LONG		60	60			
						U-LG / MAX.		90	95	35	35	
	FD-420-05R	2 m (FREE CUT)	R1	-40 to 60 °C	Ø 0.0125 mm	U-FST		5	10			●
						FAST		10	20			
						STD		20	35			
						LONG		40	80			
						U-LG / MAX.		60	120	35	30	
	FD-620-10R	2 m (FREE CUT)	R1	-40 to 60 °C	Ø 0.04 mm	U-FST		45	55			-
						FAST		70	85			
						STD		120	130			
						LONG		275	335			
						U-LG / MAX.		420	480	130	15	

01) When setting the maximum sensitivity for each amplifier.

### ■ Dimensions

• Unit: mm, For the detailed drawings, follow the Autonics website.

#### • FD-320-05R

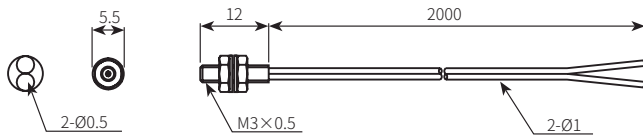

#### • FD-420-05R

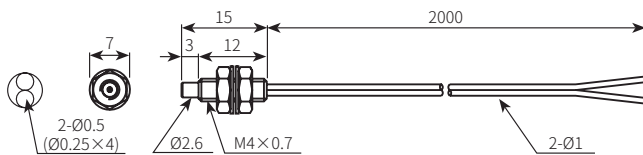

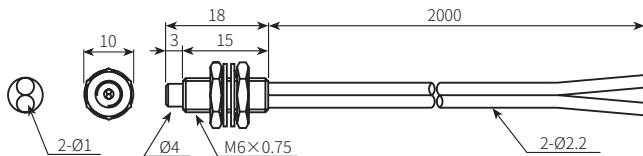

#### • FD-620-10R





## Cylindrical head: Standard

Appearance	Model	Cable		Ambient temperature	Min. target size	Sensing distance (unit: mm)				Adapter	
		Length	Bend radius			Mode	Amp.r	BFX-D1-□	BF5R-□1-□		BF4R□-□ <sup>02)</sup>
	FDC-320-05	2 m (FREE CUT)	R15	-40 to 70 °C	Ø 0.03 mm	U-FST	15	15	-	-	●
						FAST	20	20			
						STD	40	50			
						LONG	80	85			
						U-LG / MAX.	120	140			
	FDC-320-F <sup>01)</sup>	2 m (FREE CUT)	R10	-40 to 70 °C	Ø 0.03 mm	U-FST	15	15	-	-	●
						FAST	20	25			
						STD	35	55			
						LONG	80	110			
						U-LG / MAX.	120	160			

01) The micro-spot lens unit (FDC-2, sold separately) can be equipped with this fiber.

02) When setting the maximum sensitivity for each amplifier.

### ■ Dimensions

• Unit: mm, For the detailed drawings, follow the Autonics website.

#### • FDC-320-05

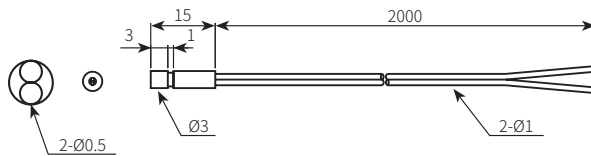

#### • FDC-320-F

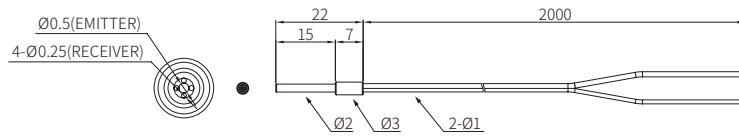

## Cylindrical head: Bending-resistant

Appearance	Model	Cable		Ambient temperature	Min. target size	Sensing distance (unit: mm)				Adapter	
		Length	Bend radius			Mode \ Amp.	BFX-D1-□	BF5R-□1-□	BF4R□-□ <sup>01)</sup>		BF3RX-□ <sup>01)</sup>
	FDC-320-06B	2 m (FREE CUT)	R5	-40 to 60 °C	Ø 0.0125 mm	U-FST	15	10			●
						FAST	20	20			
						STD	40	50			
						LONG	85	85			
						U-LG / MAX.	120	115	35	5	

01) When setting the maximum sensitivity for each amplifier.



### ■ Dimensions

• Unit: mm, For the detailed drawings, follow the Autonics website.

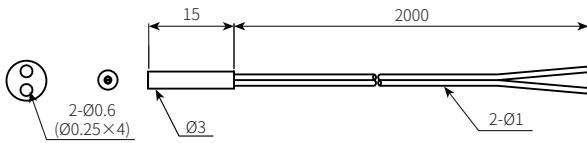
#### • FDC-320-06B



## Flat head: Flexible

Appearance	Model	Cable		Ambient temperature	Min. target size	Sensing distance (unit: mm)				Adapter	
		Length	Bend radius			Amp. Mode	BFX-D1-□	BF5R-□1-□	BF4R□-□ <sup>01)</sup>		BF3RX-□ <sup>01)</sup>
	FDF-210-05R	1 m (FREE CUT)	R1	-40 to 60 °C	Ø 0.0125 mm	U-FST	10	10			●
						FAST	15	20			
						STD	25	30			
						LONG	55	60			
						U-LG / MAX.	60	95	20	10	
	FDFN-210-05R	1 m (FREE CUT)	R1	-40 to 60 °C	Ø 0.0125 mm	U-FST	5	10			●
						FAST	10	15			
						STD	25	30			
						LONG	65	70			
						U-LG / MAX.	100	105	20	15	
	FDFU-210-05R	1 m (FREE CUT)	R1	-40 to 60 °C	Ø 0.0125 mm	U-FST	10	5			●
						FAST	15	15			
						STD	25	35			
						LONG	65	90			
						U-LG / MAX.	105	130	35	10	

01) When setting the maximum sensitivity for each amplifier.

### ■ Dimensions

• Unit: mm, For the detailed drawings, follow the Autonics website.

#### • FDF-210-05R

Hood material: SUS303, flat view

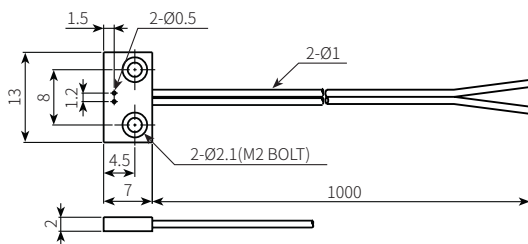

#### • FDFN-210-05R

Hood material: SUS303, side view

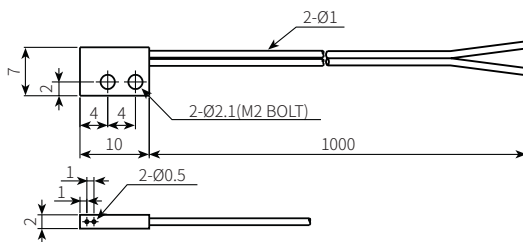

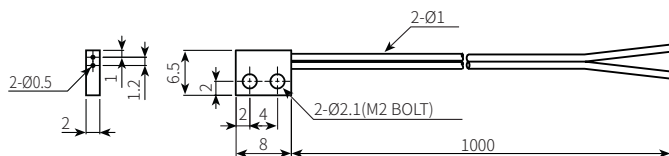

#### • FDFU-210-05R

Hood material: SUS303, top view



## L-shaped head: Heat-resistant

Appearance	Model	Cable		Ambient temperature	Min. target size	Sensing distance (unit: mm)				Adapter	
		Length	Bend radius			Mode \ Amp.	BFX-D1-□	BF5R-□1-□	BF4R-□-□ <sup>01)</sup>		BF3RX-□ <sup>01)</sup>
	GDL-620-12H2	2 m	R25	-60 to 250 °C	Ø 0.08 mm	U-FST	80	80			-
						FAST	125	130			
						STD	200	260			
						LONG	355	430			
						U-LG / MAX.	545	590	200	N.A	
	GDL-620-12H3	2 m	R25	-60 to 350 °C	Ø 0.08 mm	U-FST	75	80			-
						FAST	110	140			
						STD	160	260			
						LONG	300	410			
						U-LG / MAX.	460	550	175	N.A	

01) When setting the maximum sensitivity for each amplifier.

### ■ Dimensions

• Unit: mm, For the detailed drawings, follow the Autonics website.

#### • GDL-620-12H2

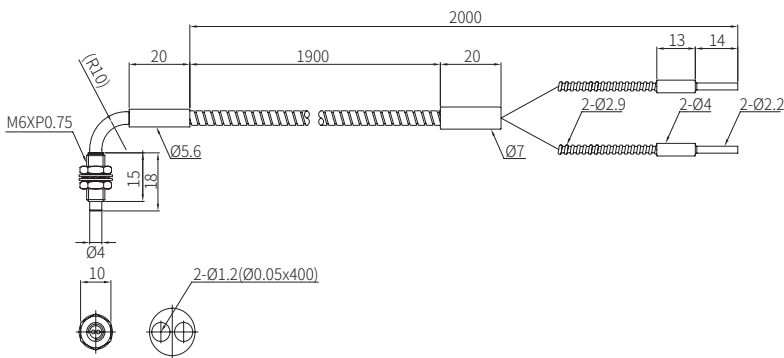

#### • GDL-620-12H3

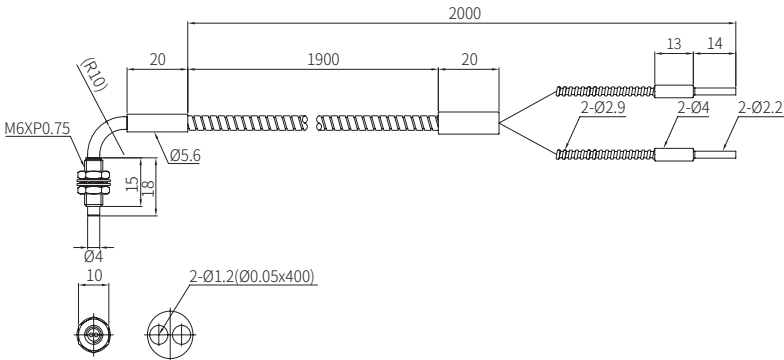

## L-shaped head: Vacuum-resistant

- Be sure to connect with the vacuum-resistant fiber, the fiber optic coupler, and the atmospheric side fiber.
- The sensing distance of the vacuum-resistant fiber unit is based on the installation of the atmospheric side fiber unit (FU-VA0□, sold separately).

Appearance	Model	Cable		Ambient temperature	Min. target size	Sensing distance (unit: mm)				Adapter	
		Length	Bend radius			Amp. Mode	BFX-D1-□	BF5R-□1-□	BF4R□-□ <sup>01)</sup>		BF3RX-□ <sup>01)</sup>
	GDL-610-12V2	1 m	R25	-60 to 250 °C	Ø 0.08 mm (+ FU-VA01)	U-FST	40	60			
						FAST	55	90			
						STD	90	180			
						LONG	185	300			
						U-LG / MAX.	255	380	80	80	
					Ø 0.08 mm (+ FU-VA02)	U-FST	20	40			
						FAST	35	60			
						STD	60	130			
						LONG	130	230			
						U-LG / MAX.	185	320	55	60	

01) When setting the maximum sensitivity for each amplifier.

### ■ Dimensions

- Unit: mm, For the detailed drawings, follow the Autonics website.

#### • GDL-610-12V2

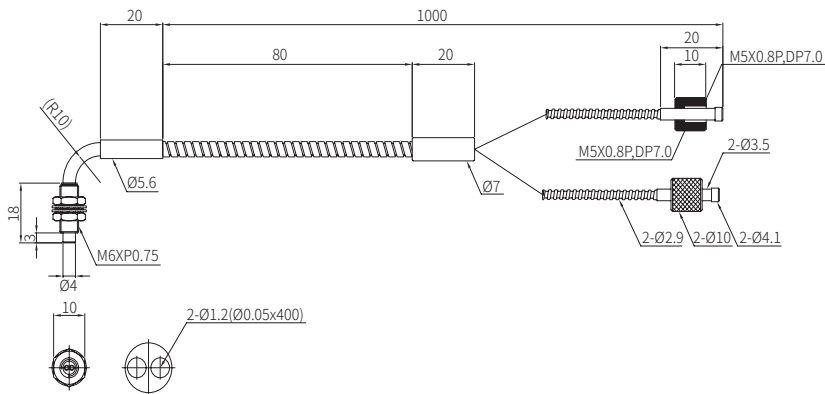

## Molded plastic head: Standard

Appearance	Model	Cable		Ambient temperature	Min. target size	Sensing distance (unit: mm)				Adapter	
		Length	Bend radius			Mode \ Amp.	BFX-D1-□	BF5R-□1-□	BF4R□-□ <sup>01)</sup>		BF3RX-□ <sup>01)</sup>
	FDP-320-10	2 m (FREE CUT)	R25	-40 to 70 °C	Ø 0.03 mm	U-FST	55	65			
						FAST	75	100			
						STD	110	160			
						LONG	175	230			
						U-LG / MAX.	200	280	120	15	

01) When setting the maximum sensitivity for each amplifier.

### ■ Dimensions

• Unit: mm, For the detailed drawings, follow the Autonics website.

#### • FDP-320-10

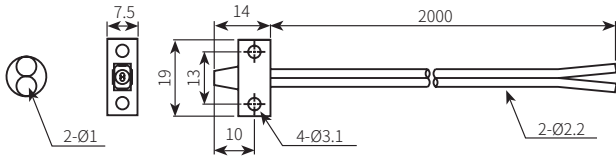

## Molded plastic head: Flexible

Appearance	Model	Cable		Ambient temperature	Min. target size	Sensing distance (unit: mm)				Adapter	
		Length	Bend radius			Mode	Amp.	BFX-D1-□	BF5R-□1-□		BF4R□-□ <sup>01)</sup>
	FDPF-210-05R	1 m (FREE CUT)	R1	-30 to 70 °C	Ø 0.08 mm	U-FST	10	20	-	-	●
						FAST	20	30			
						STD	35	70			
						LONG	80	140			
						U-LG / MAX.	115	210			

01) When setting the maximum sensitivity for each amplifier.



### ■ Dimensions

• Unit: mm, For the detailed drawings, follow the Autonics website.

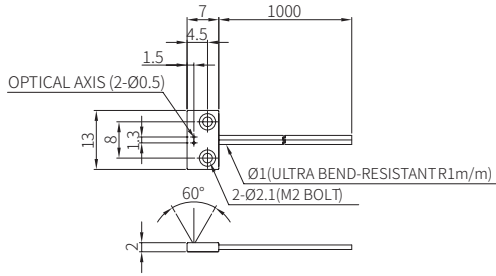
#### • FDPF-210-05R



## Perpendicular head: Heat-resistant

Appearance	Model	Cable		Ambient temperature	Min. target size	Sensing distance (unit: mm)				Adapter		
		Length	Bend radius			Mode	Amp.	BFX-D1-□	BF5R-□1-□		BF4R-□-□ <sup>01)</sup>	BF3RX-□ <sup>01)</sup>
	GDR-620-17H2	2 m	R25	-60 to 250 °C	Ø 0.08 mm	U-FST		80	80			
						FAST		120	140			
						STD		200	250			
						LONG		320	410			
						U-LG / MAX.		405	540	310	N.A	
	GDR-620-17H3	2 m	R25	-60 to 350 °C	Ø 0.08 mm	U-FST		65	80			
						FAST		110	140			
						STD		165	260			
						LONG		335	410			
						U-LG / MAX.		560	560	185	N.A	

01) When setting the maximum sensitivity for each amplifier.

### ■ Dimensions

• Unit: mm, For the detailed drawings, follow the Autonics website.

#### • GDR-620-17H2

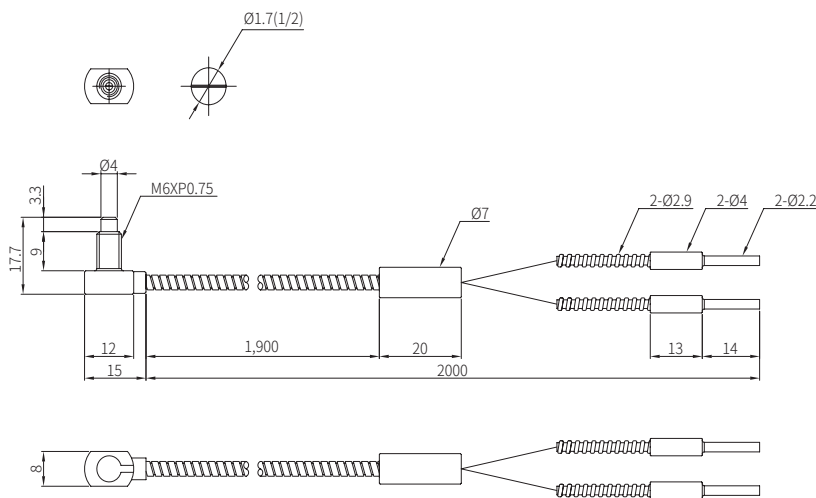

#### • GDR-620-17H3

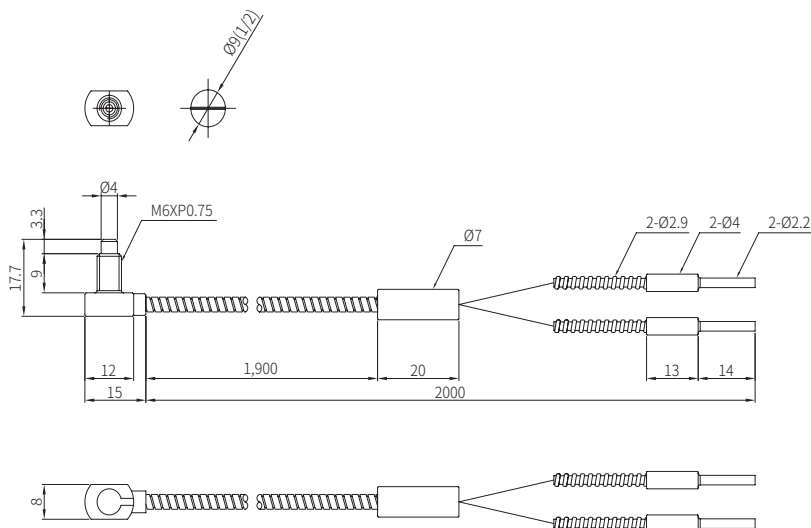



## Perpendicular head: Bending-resistant

Appearance	Model	Cable		Ambient temperature	Min. target size	Sensing distance (unit: mm)				Adapter	
		Length	Bend radius			Mode \ Amp.	BFX-D1-□	BF5R-□1-□	BF4R□-□ <sup>01)</sup>		BF3RX-□ <sup>01)</sup>
	FDRT-420-02B	2 m (FREE CUT)	R5	-30 to 70 °C	Ø 0.08 mm	U-FST	50	70	-	-	-
						FAST	70	110			
						STD	125	230			
						LONG	250	390			
						U-LG / MAX.	440	540			

01) When setting the maximum sensitivity for each amplifier.

### ■ Dimensions

• Unit: mm, For the detailed drawings, follow the Autonics website.

#### • FDRT-420-02B

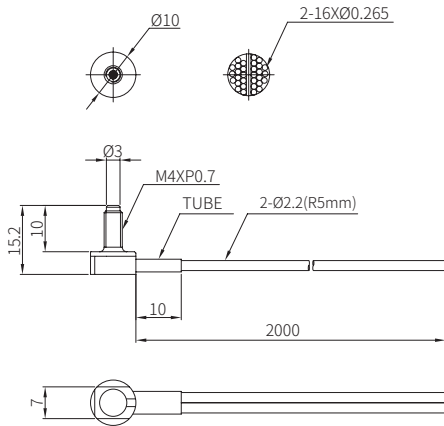

## Perpendicular head: Flexible

Appearance	Model	Cable		Ambient temperature	Min. target size	Sensing distance (unit: mm)				Adapter	
		Length	Bend radius			Mode \ Amp.	BFX-D1-□	BF5R-□1-□	BF4R□-□ <sup>01)</sup>		BF3RX-□ <sup>01)</sup>
	FDR-610-10R	1 m (FREE CUT)	R1	-40 to 60 °C	Ø 0.04 mm	U-FST	40	45			-
						FAST	60	85			
						STD	110	120			
						LONG	265	345			
						U-LG / MAX.	440	485	160	5	

01) When setting the maximum sensitivity for each amplifier.

### ■ Dimensions







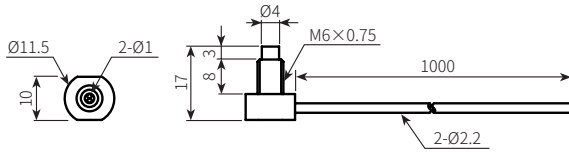

• Unit: mm, For the detailed drawings, follow the Autonics website.

#### • FDR-610-10R

Hood material: SUS303



**SUS head: Standard**

Appearance	Model	Cable		Ambient temperature	Min. target size	Sensing distance (unit: mm)					Adapter
		Length	Bend radius			Mode	Amp.	BFX-D1-□	BF5R-□1-□	BF4R□-□ <sup>01)</sup>	
	FDS-320-05	2 m (FREE CUT)	R15 (SUS part R10)	-40 to 70 °C	Ø 0.03 mm	U-FST	15	15	-	-	-
						FAST	25	30			
						STD	45	70			
						LONG	100	120			
						U-LG / MAX.	180	240			
	FDS-420-05	2 m (FREE CUT)	R15 (SUS part R10)	-40 to 70 °C	Ø 0.03 mm	U-FST	20	15	-	-	●
						FAST	30	25			
						STD	50	65			
						LONG	135	120			
						U-LG / MAX.	180	180			
	FDS-620-10	2 m (FREE CUT)	R25 (SUS part R10)	-40 to 70 °C	Ø 0.03 mm	U-FST	70	75	-	-	-
						FAST	110	135			
						STD	180	265			
						LONG	315	435			
						U-LG / MAX.	580	655			
	FDS2-320-05	2 m (FREE CUT)	R15 (SUS part R10)	-40 to 70 °C	Ø 0.03 mm	U-FST	15	15	-	-	●
						FAST	20	25			
						STD	40	60			
						LONG	95	135			
						U-LG / MAX.	175	230			
	FDS2-420-05	2 m (FREE CUT)	R15 (SUS part R10)	-40 to 70 °C	Ø 0.03 mm	U-FST	20	20	-	-	●
						FAST	30	30			
						STD	55	70			
						LONG	135	125			
						U-LG / MAX.	240	200			
	FDS2-620-10	2 m (FREE CUT)	R25 (SUS part R10)	-40 to 70 °C	Ø 0.03 mm	U-FST	65	80	-	-	-
						FAST	100	130			
						STD	160	245			
						LONG	320	455			
						U-LG / MAX.	680	565			
	FDCS-320-05	2 m (FREE CUT)	R15 (SUS part R10)	-40 to 70 °C	Ø 0.03 mm	U-FST	10	2	-	-	●
						FAST	20	3			
						STD	40	8			
						LONG	100	15			
						U-LG / MAX.	175	20			
	FDCSN-320-05	2 m	R15	-40 to 60 °C	Ø 0.0125 mm	U-FST	6	5	-	-	○ <sup>02)</sup>
						FAST	8	15			
						STD	10	30			
						LONG	35	50			
						U-LG / MAX.	70	100			

01) When setting the maximum sensitivity for each amplifier.

02) The adapter for this model is not compatible with the separately sold adapter and cannot be purchased separately, so be careful not to lose it.

## ■ Dimensions

• Unit: mm, For the detailed drawings, follow the Autonics website.

### • FDS-320-05

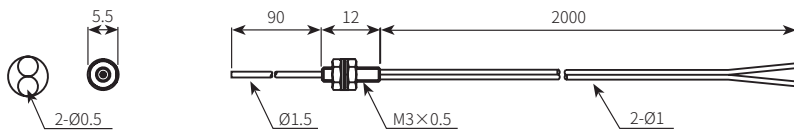

### • FDS-420-05

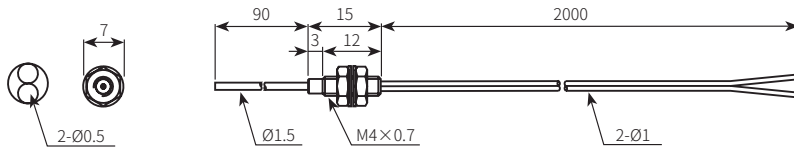

### • FDS-620-10

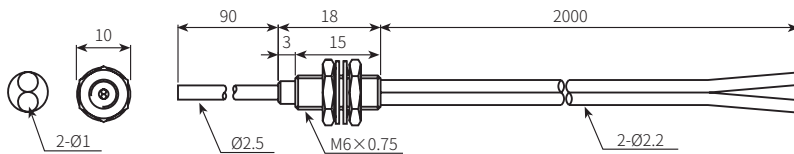

### • FDS2-320-05

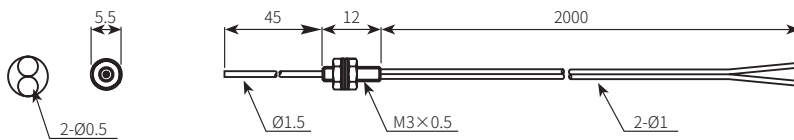

### • FDS2-420-05

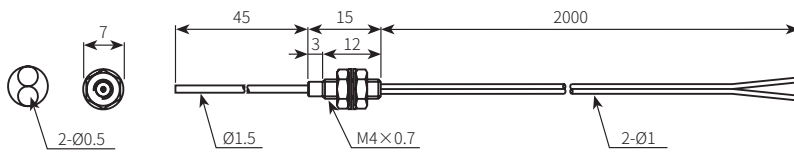

### • FDS2-620-10

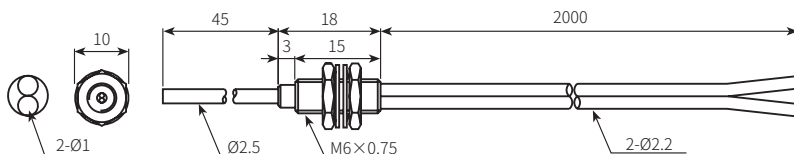

### • FDCS-320-05

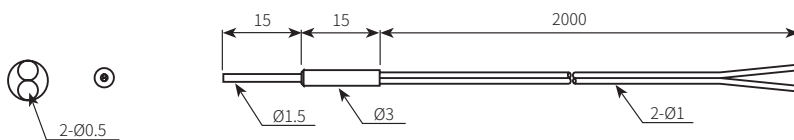

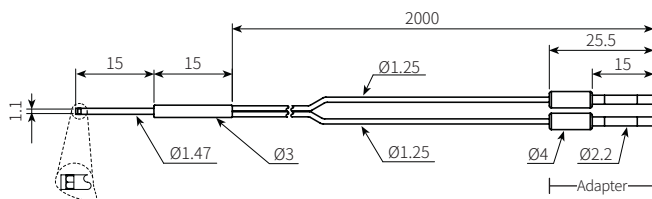

### • FDCSN-320-05

Side view



## Wide area head: Bending-resistant

Appearance	Model	Cable		Ambient temperature	Min. target size	Sensing distance (unit: mm)				Adapter	
		Length	Bend radius			Mode	Amp.	BFX-D1-□	BF5R-□1-□		BF4R□-□ <sup>01)</sup>
	FDW10-320-02B	2 m (FREE CUT)	R5	-30 to 70 °C	Ø 0.08 mm	U-FST	40	75	-	-	-
						FAST	60	120			
						STD	100	230			
						LONG	240	390			
						U-LG / MAX.	385	510			
	FDW10T-320-02B	2 m (FREE CUT)	R5	-30 to 70 °C	Ø 0.08 mm	U-FST	45	75	-	-	-
						FAST	70	120			
						STD	120	230			
						LONG	275	390			
						U-LG / MAX.	485	510			

01) When setting the maximum sensitivity for each amplifier.

### ■ Dimensions

• Unit: mm, For the detailed drawings, follow the Autonics website.

#### • FDW10-320-02B

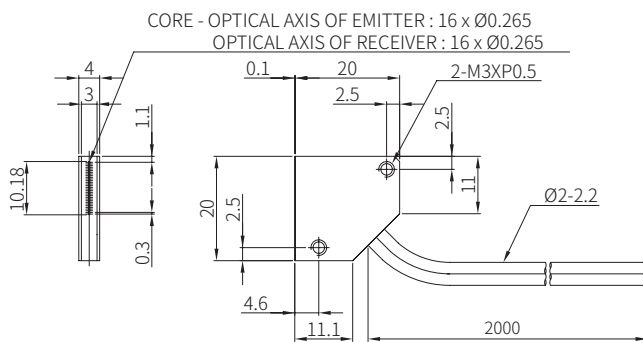

#### • FDW10T-320-02B

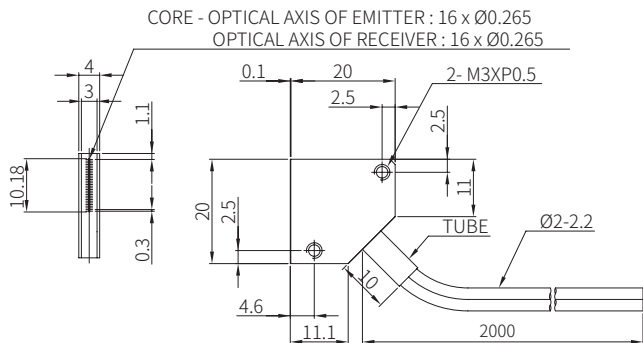

## Sold Separately: Fiber Optic Coupler, Atmospheric side fiber

### ■ Cautions during installation

- When using the vacuum-resistant fibers, be sure to connect with the fiber optic coupler and the atmospheric side fibers.
- The fiber optic coupler is a device that seals the vacuum side and the atmospheric side to transmit light, and it is equipped with an O-ring. Be sure not to blur the glass rod inside by welding on the vacuum wall and weld joints.
- When installing the fiber optic coupler, following the environmental requirements below.
  - Thickness of the installation wall: 8 to 10 mm
  - Diameter of the mounting hole:  $\varnothing 5.0 + 0.1, - 0.1$  mm
  - Surface roughness in contact with the O-ring: 1.6 Ry
- Be sure to install the fiber optic coupler and fiber optic units by checking the specified connection points below. Failure to follow this instruction may result in product damage.
  - Vacuum side fibers → Long side of the fiber optic coupler
  - Atmospheric side fibers → Short side of the fiber optic coupler

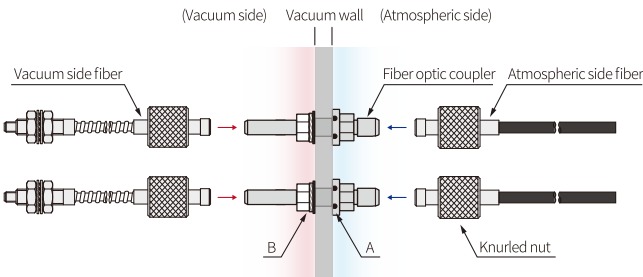

### ■ Example of usage

01. Insert the fiber optic coupler into the mounting hole of the vacuum wall.
02. From the long side of the fiber optic coupler, insert a flat washer, followed by a spring washer, and then a nut to the direction of the vacuum wall. Tighten the nut to secure the fiber optic coupler.
03. Turn the knurled nuts of the vacuum side and atmospheric side fibers to connect them with the fiber optic coupler.



- A. O-ring  
B. An M5 nut + a spring washer + a flat washer

### ■ Fiber optic coupler

Appearance	Ambient temperature	Applicable cable	Model
	-60 to 200 °C	Vacuum-resistant type, Atmospheric side type	FU-VC01
	-60 to 300 °C	Vacuum-resistant type, Atmospheric side type	FU-VC02

- Helium leak testing:  $\leq 10^{-11}$  Pa · m<sup>3</sup>/s
- Product components: Fiber optic coupler, M5 nut, spring washer, flat washer (each × 2)



### ■ Dimensions

Unit: mm, For the detailed drawing, follow the Autonics website.

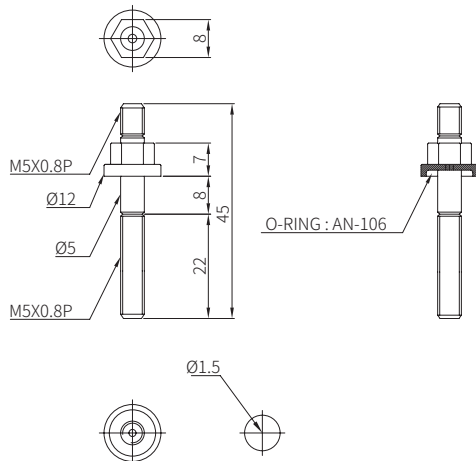
#### • FU-VC01, FU-VC02



### ■ Atmospheric side fiber

Appearance	Bend radius	Ambient temperature	FREE CUT	Model
	R30	-30 to 70 °C	FREE CUT	FU-VA01
	R20	-30 to 70 °C	FREE CUT	FU-VA02

- Product components: Atmospheric side fiber × 2, Fiber cutter (FC-3) × 1

### ■ Dimensions

Unit: mm, For the detailed drawing, follow the Autonics website.

#### • FU-VA01

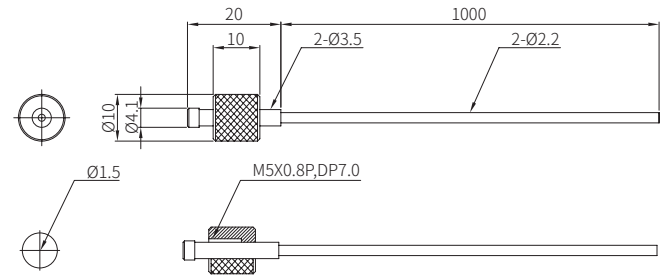

#### • FU-VA02

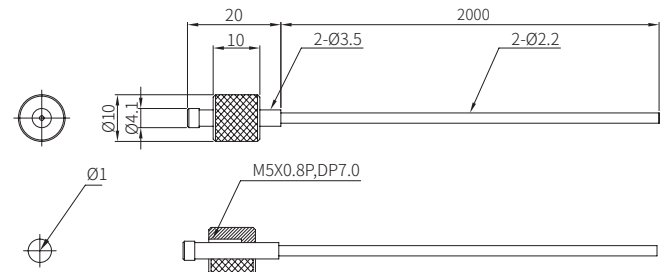

### Sold Separately: Micro-Spot Lens Unit

The lens unit can be used when detecting small objects.

- Supported fiber optic unit: FDC-320-F

Model	Ambient temperature	Dimensions (unit: mm)
FDC-2	-40 to 100 °C	

### Characteristic curve

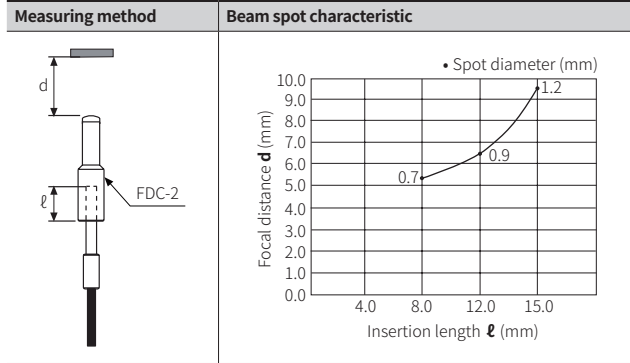

### Sensing distance

Lens insertion length (l)	Sensing distance (unit: mm)				
	Amp. Mode	BFX-D1-□	BF5R-□1-□	BF4R-□-□	BF3RX-□
8 mm	U-FST	6	6		
	FAST	8	9		
	STD	12	15		
	LONG	25	30		
	U-LG / MAX.	55	50	N.A.	N.A.
12 mm	U-FST	5	5		
	FAST	10	10		
	STD	15	20		
	LONG	35	35		
	U-LG / MAX.	75	80	N.A.	N.A.
15 mm	U-FST	15	20		
	FAST	20	25		
	STD	35	45		
	LONG	70	85		
	U-LG / MAX.	140	135	N.A.	N.A.

### Sold Separately: Fiber Cutter

Model	Hole diameter	Appearance
FC-3	$\varnothing 2.4 \times 4$ $\varnothing 1.4 \times 4$	

### Sold Separately: Cable Protection Tube

Be sure to consider the diameter of the fiber optic cable and choose a suitable protection tube for the fiber cable.

- Diameter of cable: Cable protection tube > Fiber optic unit

Model	Length (L)	Dimensions (unit: mm)
FDH-605	500 mm	
FDH-610	1,000 mm	

### Sold Separately: Adapter

The additional adapter for the Adapter-compatible models can be purchased through an authorized distributor of Autronics.

Model	Feature	Dimensions (unit: mm)
B1700000047	Inner diameter: $\varnothing 1$ Color: black	
B1700000046	Inner diameter: $\varnothing 1.3$ Color: dark gray	

## Ordering Information

This is only for reference, the actual product does not support all combinations. For selecting the specified model, follow the Autonics website.

• Example of ordering information: FD-620-10H

F	D	□	-	6	20	-	10	H	□
①	②	③	-	④	⑤	-	⑥	⑦	⑧

①	Fiber material	F	Plastic
		G	Glass
②	Sensing type	D	Retroreflective type
		L	Convergent reflective type
		T	Through-beam type
③	Head shape		
		· Threaded head	No mark Standard
	· Cylindrical head	C	Standard
		CS	Cylinder+SUS head (SUS length 15 mm)
		CSN	Cylinder+SUS head (SUS length 15 mm, side view)
	· Flat head	F	Flat view
		FB	Side view+Top view (bending)
		FN	Side view
		FU	Top view (up)
		LU	L-shaped head top view (height 12.2 mm)
		LU1	L-shaped head top view (height 17.2 mm)
	· L-shaped head	LU2	L-shaped head top view (height 22.2 mm)
		L	Standard
		P	Standard
	· Molded plastic head	PF	Flat view
		R	Standard
	· Perpendicular head	RT	Protection tube mounted
		S	SUS length 90 mm
	· SUS head	S1	SUS length 35 mm
		S2	SUS length 45 mm
		U3	Beam width 3 mm
	· U-shaped head	W5	Beam width 5 mm
		· Wide area head	W10
	W10T		Beam width 10 mm, protection tube mounted
	W11		Beam width 11 mm
	· Protection tube	H	Protection tube for fiber cable (sold separately)
		④	Hood diameter
2	∅ 2 mm (M2)		
3	∅ 3 mm (M3)		
4	∅ 4 mm (M4)		
6	∅ 6 mm (M6)		

⑤	Cable length	5	0.5 m	
		10	1 m	
		20	2 m	
		10M	10 m	
⑥	Fiber diameter	2	∅ 0.2 mm	
		5	∅ 0.5 mm	
		6	∅ 0.6 mm	
		10	∅ 1.0 mm	
		12	∅ 1.2 mm	
		13	∅ 1.3 mm	
		14	∅ 1.4 mm	
		15	∅ 1.5 mm	
		17	∅ 1.7 mm	
		20	∅ 2.0 mm	
		F	∅ 0.5 mm, ∅ 0.25 mm×4 (coaxial type)	
		F1	∅ 0.5 mm, ∅ 0.25 mm×9 (coaxial type)	
		F2	∅ 1.0 mm, ∅ 0.265 mm×16 (coaxial type)	
		⑦	Unit type	No mark
B	Bending-resistant (R5)			
R	Flexible (R1, R2)			
H	Heat-resistant (-40 to 105 °C)			
H1	Heat-resistant (-40 to 150 °C)			
H2	Heat-resistant (-60 to 250 °C)			
H3	Heat-resistant (-60 to 350 °C)			
V	Vacuum-resistant (-60 to 100 °C)			
V1	Vacuum-resistant (-60 to 150 °C)			
V2	Vacuum-resistant (-60 to 250 °C)			
V3	Vacuum-resistant (-60 to 350 °C)			
⑧	Convergent reflective type size option	A	R20 / 12×18×3	
		L	Over 30 mm of the product length	
		Waterproof sealing	WP	Water resistance supported